

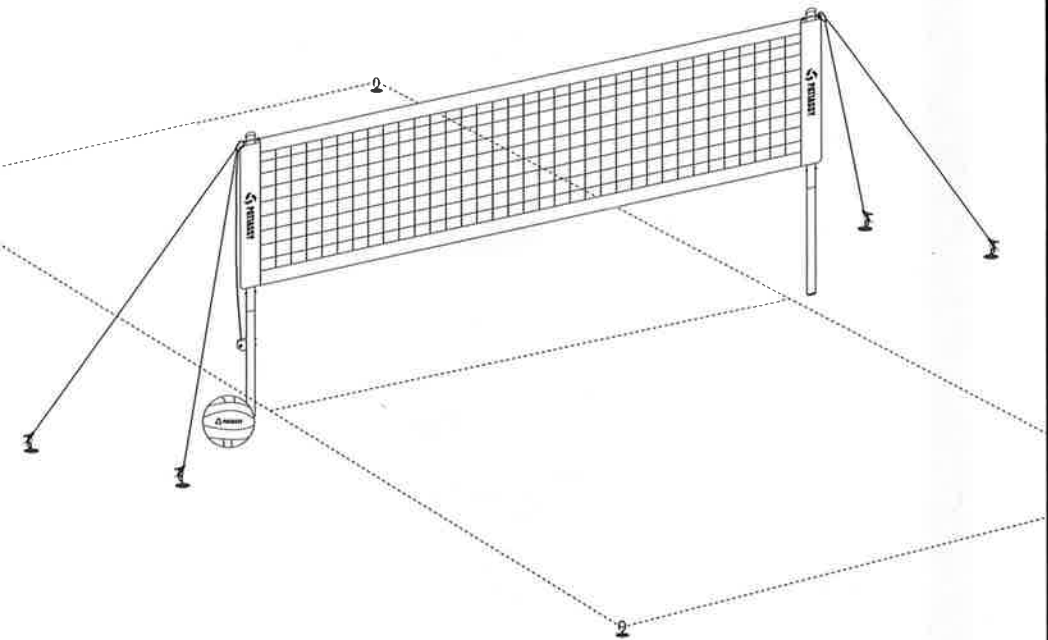











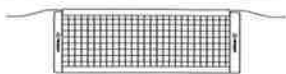

User Manual For Volleyball Set

⦿ Accessories ⦿ Assembly Instructions



Accessories

	Name		Quantity
A	Top Pole		2
B	Bottom Pole 1		1
C	Bottom Pole 2		1
D	Net		1
E	Guide rope		2
F	Carabiner		2
G	Circle Site		1
H	Volleyball		1
I	Air Pump		1
J	Spool for Boundary Line		1
K	Tension Adjuster - A		1
L	Tension Adjuster - B		1

Assembly Instructions

Step 1: BEFORE ASSEMBLY

1. Find a clean, level place to begin the assembly of your product.
2. Verify that you have all listed parts as shown on the part list pages.

Step 2: Unfold the ribbon webbing and straighten it, then fix the ground nails to form a 30'x60ft field as shown in the picture.

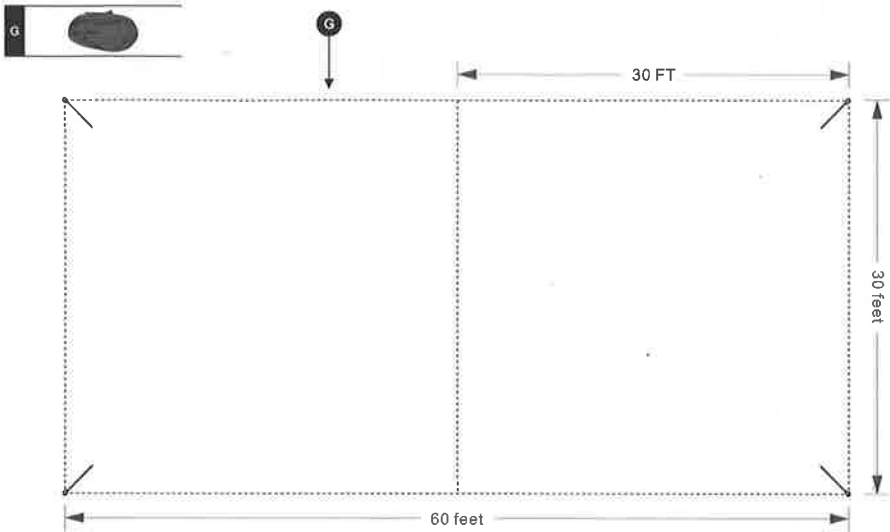

Step 3: Pass the upper part of the aluminum pole through the side of the net.

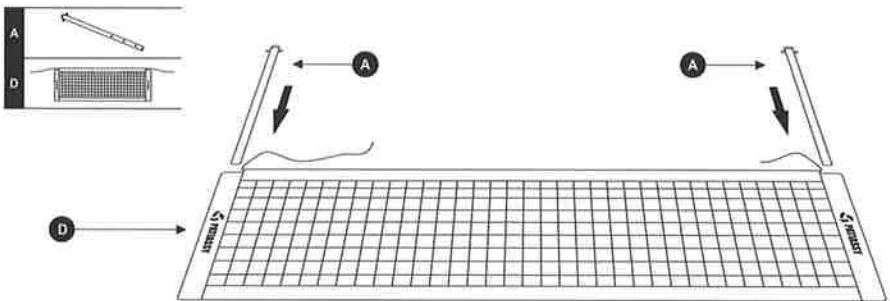

Step 4: Connect the upper and bottom parts of the aluminum pole, and pass one end of the pole on the net side through the eyebolt set, and connect it to the tension adjuster. The other end is attached to the eyebolt set.

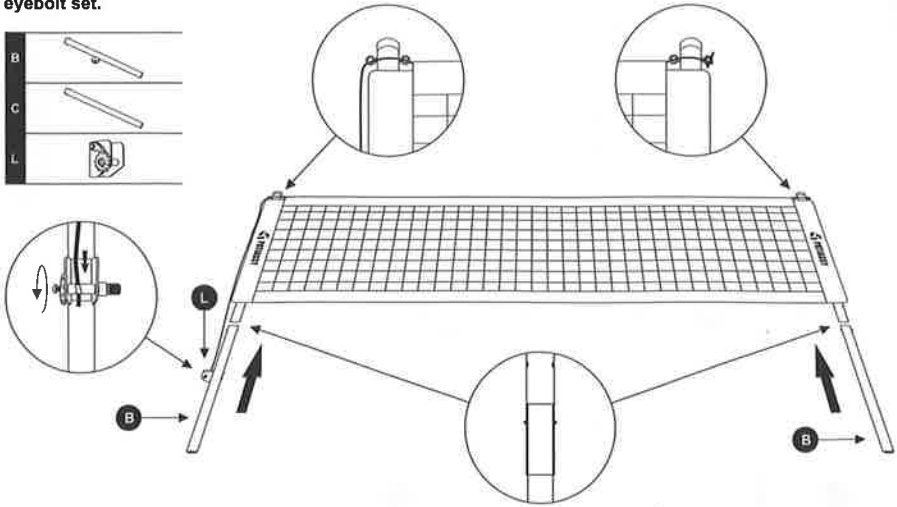

Step 5: Fasten the carabiner on the guide rope and the eyebolt set on the aluminum pole, and nail the needle on the guide rope to the ground, to make that the distance between the single guide rope and the two ground nails is 3 to 4 feet. Then, erect the aluminum poles, keep them vertical, adjust the guide rope and plastic fork to fix the erected aluminum poles.

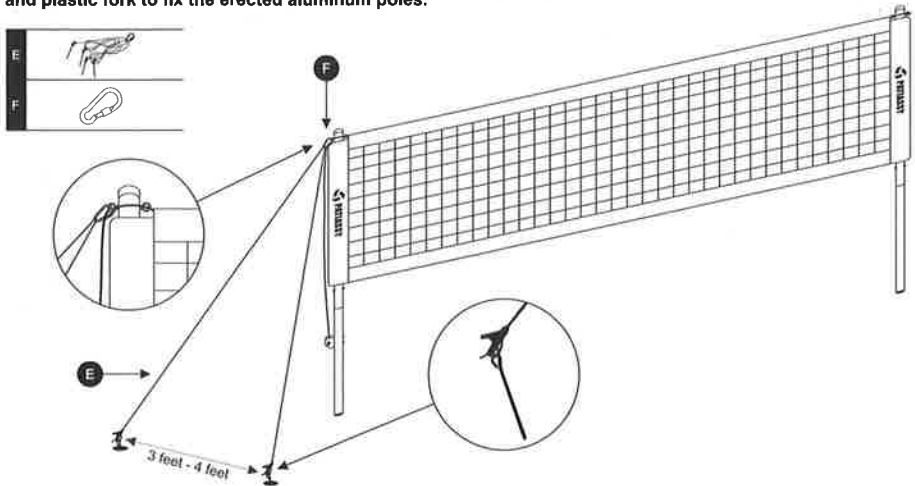

Step 6: Adjust the tension adjuster to straighten the net. Operation of tension adjuster as following:

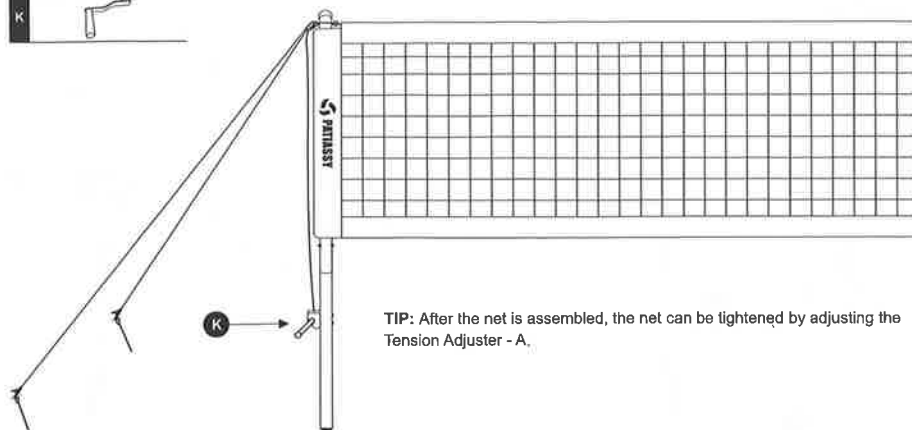

TIP: After the net is assembled, the net can be tightened by adjusting the Tension Adjuster - A.

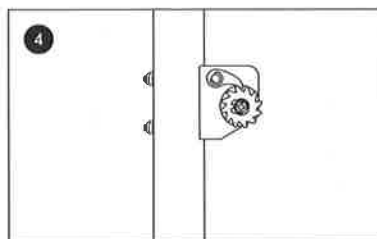
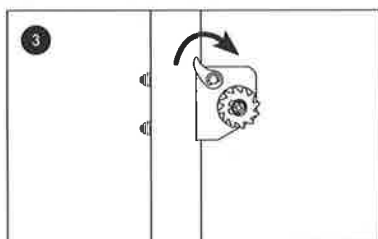
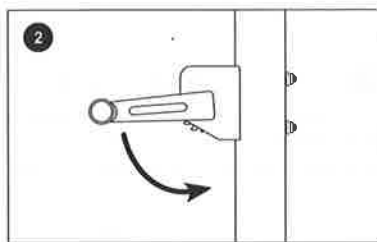
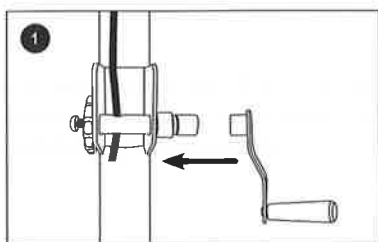

Operation of aluminum rod height adjustment as following:

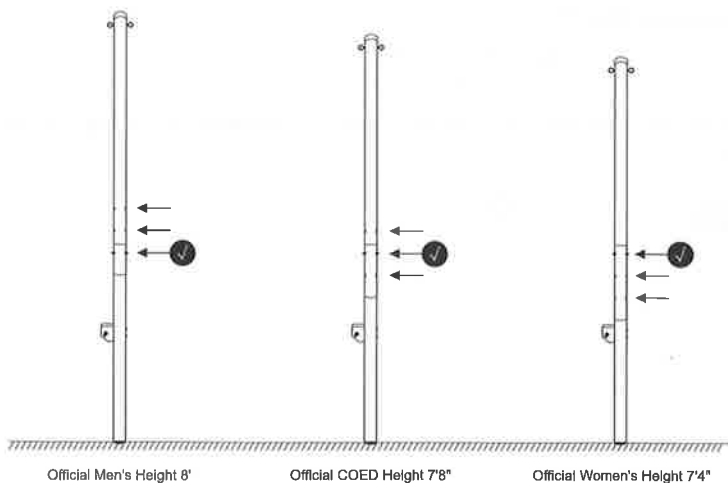

WARNING!

Adult Assembly Required.

CHOKING HAZARD - This item contains small parts.

Not suitable for children under 3 years.